

ACCENT GIMBLE DOWNLIGHT

SKU#177650, 177651, 177652, 177653, 177654, 177655

Rated Voltage 220-240V~ 50Hz

Thank you for purchasing this quality MFL product. To ensure correct function and safety, please read and follow all instructions carefully before assembly, installation and use. Please keep instructions for future reference.

Warranty

- This light fitting is covered by a 5 year warranty. The warranty is from date of purchase, not the date of installation. Please retain proof of purchase.
- The use of non-compatible dimmers may damage your LED light fitting and will void your warranty.
- Warranty will be void if there is any damage due to improper usage or modification to the fitting.
- Failure to comply with the instructions in this manual may increase the risk of damage or injury and will void warranty.

Installation Requirements

- Before installation, check the installation location in the ceiling has access to a socket outlet which is connected to a wall light switch and dimmer. If it does not, please contact a licensed electrician to arrange installation of the socket outlet, wall light switch and dimmer before continuing.
- All wiring and installation of the light fitting must adhere to local and national wiring rules. eg. AS/NZS 3000:2007/Amendment 2:2012 Electrical installations. If unsure, please contact a licensed electrician.
- Select a suitable location for installation:
 - The mounting point must support 2 times the weight of the fitting.
 - This fitting is suitable for indoor use.
 - Ensure the fitting is not installed in direct line of an air vent/system.
 - If installing a fitting in an area prone to moisture, ensure that the area is well ventilated and an appropriately rated exhaust fan is used if required. Damage or corrosion caused by moisture is not a product fault, and as such is not covered under warranty.
- This fitting is dimmable and has been tested at the date of publication with the dimmers listed in the specification section. The use of a LED dimmer such as the Lucci LEDlux SKU# 290998 dimmer is highly recommended.
NOTE: For the best dimming range, use with the Lucci LEDlux SKU# 290998 dimmer and adjust the variable resistor at minimum and maximum dimming positions on the dimmer during the installation.
NOTE: Dimming may cause buzzing sounds or a slight flicker. There may be slight delays with the LED light start up or slight uneven light performance when more than one LED light fitting is linked together, switched ON or dimmed. This is not a product fault and as such is not covered under warranty.
NOTE: Some dimmers have a minimum load of 20W. Ensure the dimmer position is on the maximum setting before turning on the LED light and adjust the dimmer down to your desired light level.
NOTE: Testing cannot account for installation variables such as variation in mains supply voltage, cable capacitance, electrical noise, transients, surges and ripple control signals (commonly found in NSW & QLD).
- **NOTE:** The information provided is correct to the best of Beacon Lighting's knowledge at the date of publication. This fitting has an insulating ceiling type IC-4 rating. Building insulation material can safely be exposed continuously to temperatures up to 90°C may abut and cover the luminaire. (Please refer to the Clearance Information section and the IC-4 Rating section in this instruction manual for further details.)
- If loose fill insulation or thermal insulation is not fixed into position or if there are loose combustible materials (e.g. leaves or combustible materials stored in the roof space), a barrier or guard is required as per the Clearance Information section in this instruction manual.
- The LED driver must be placed at least 100mm away from the LED module to allow for cooling.

- The LED driver can be placed under the insulation. (Please refer to the Clearance Information section in this instruction manual for further details.)
- The LED module is only suitable for use with **LUCCI LED Driver model#:TD011GIL-E028**
- The fitting must not be used if the diffuser on the LED module has been damaged or cracked.
- Take care not to pull any electrical wires during unpacking as this may damage the connection.
- Lay out all the components on a smooth surface and make sure there are no components missing before assembling. If parts are missing, return the complete product to the place of purchase for inspection or replacement.
- Check whether the fitting has been damaged during transport. Do not operate/install any product which appears damaged in any way. Return the complete product to the place of purchase for inspection, repair or replacement.
- Ensure power to the circuit you are working on has been switched OFF before commencing any electrical work.

Installation Directions

1. Remove all packaging material from the product and be careful not to throw away accessories that may be hidden within the packaging material.
NOTE: Before installation, plug the fitting into a socket outlet to ensure the LED fitting is working correctly.
2. Cut an installation hole of Ø 82mm into the ceiling. Fig.1
3. Connect the fitting plug to the socket outlet. Fig.2
4. Press the springs in towards the lamp body and push the LED module up through the cut-out hole and into the ceiling. Fig.3
5. Ensure all the clearance values are maintained during and after installation of the LED module, LED driver, thermal insulation, loose fill insulation, loose combustible materials and any structural members. Fig.4
Please refer to the Clearance Information section and the IC-4 section in this instruction manual for further details.
6. Push the inner frame (A) of lamp body (B) by using a screw driver (C, not included) to tilt the lamp body to your preferred lighting angle. Do not exceed the maximum angle shown in Fig.5
7. This product comes with interchangeable reflectors (D, E, F) included. To change the reflector (D), pull downward to remove it, and replace with your preferred reflector (E, F). Fig. 6
8. After the installation, switch on the fitting to test and enjoy your new lighting product.

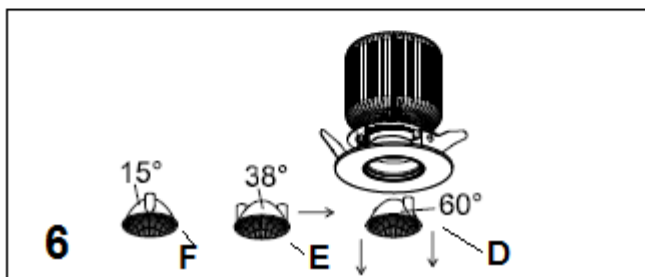
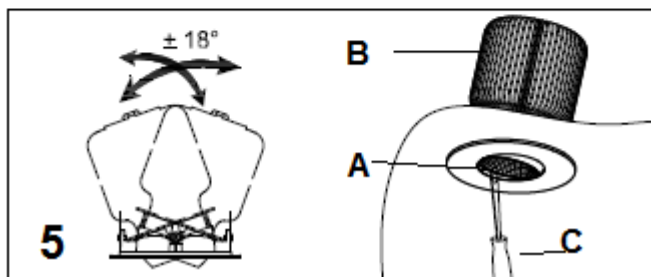
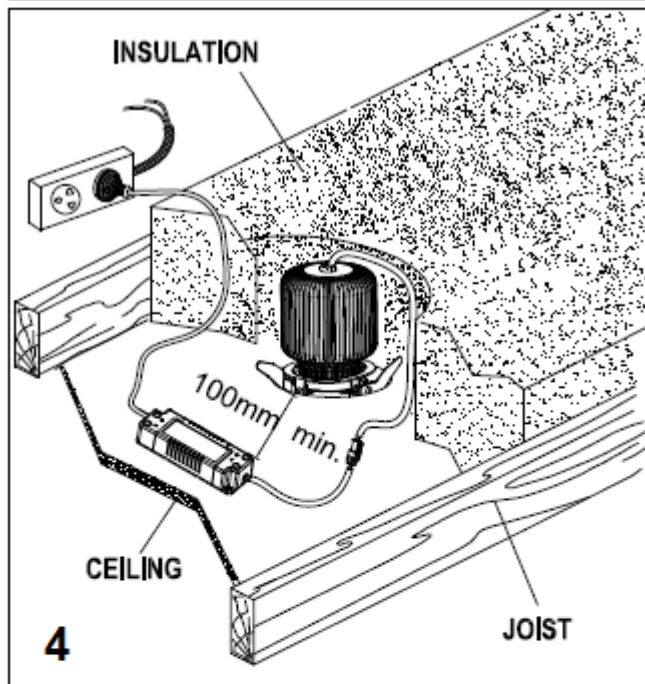
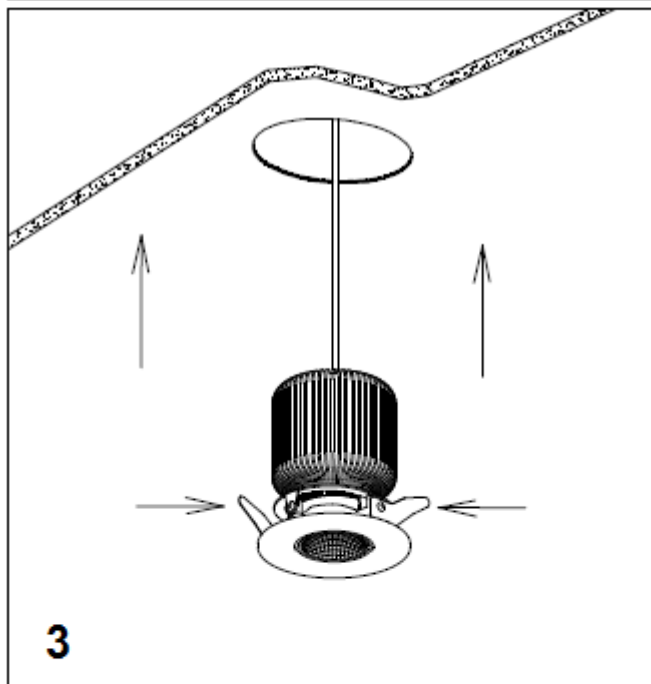
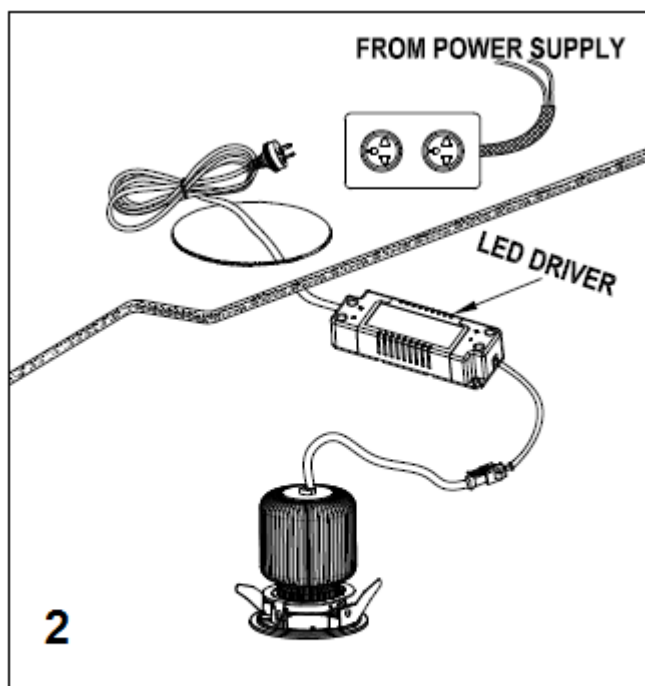
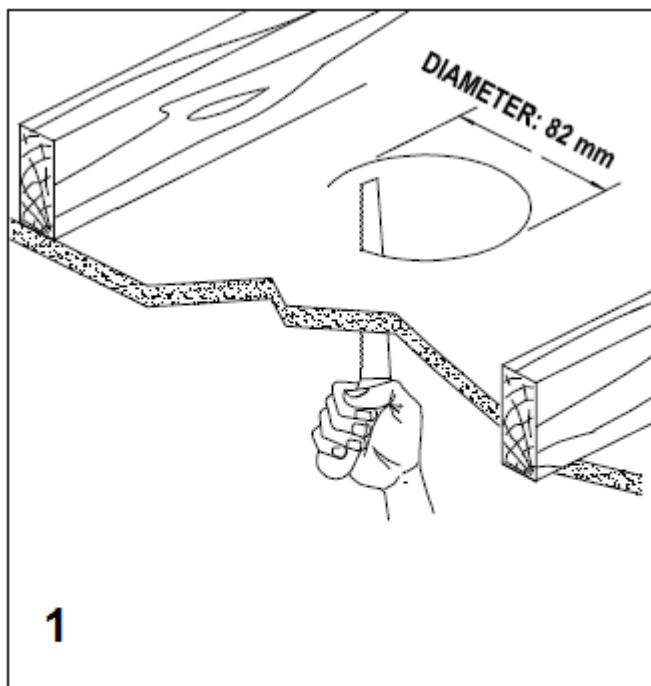

Clearance Information – AS/NZS 3000 Wiring Rules

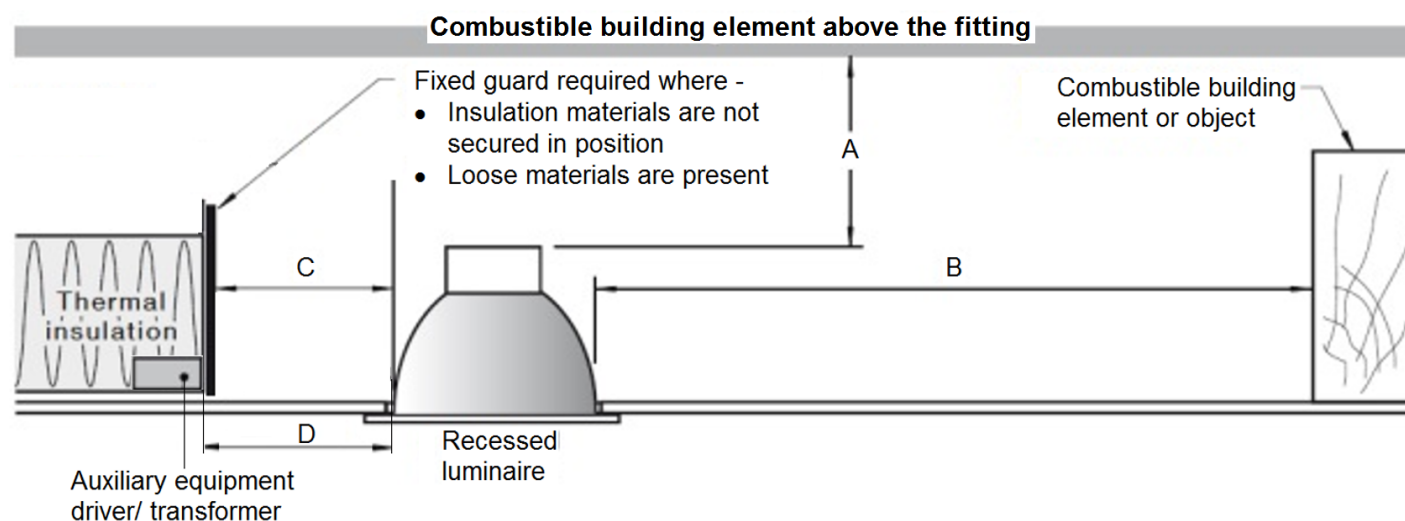

LOCATION	DISTANCE	DESCRIPTION
A	50 mm (Minimum)	Clearance between the top of the recessed luminaire and any combustible materials, building elements or objects above it.
B	50 mm (Minimum)	Clearance between the side of the recessed luminaire and any combustible materials, building elements or objects.
C	0 mm (Abutted)	Insulation can be abutted against the side of recessed luminaire and covered as per IC-4 Rating. See IC-4 Rating section for more details.
D	100mm	Auxiliary equipment/driver/transformer must be placed 100mm away from the luminaire. It can be placed under the thermal insulation and covered.

IC Rating – AS/NZS 60598.2.2 : 2016

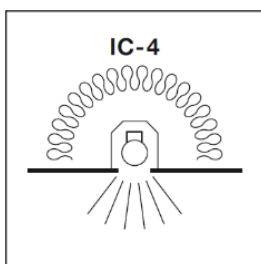

1. A closed luminaire that allows building insulation to come into contact with its sides and to cover it.
2. Type IC-4 recessed luminaire can be used together with building insulation that can safely be exposed continuously to temperatures up to 90°C may abut and cover the luminaire;
3. The declared IC-4 rating is based on the default testing ambient temperatures 25°C according to the standard.
4. The insulation material must be glasswool insulation batts type, with maximum R-value 5.0.

RISK OF FIRE – Required clearance from structural members and building elements
 SCB = 50 mm HCB = 50 mm

Safety tips

- Always ensure the power is OFF and the fitting has cooled down before performing any maintenance, cleaning or making any adjustment to the fitting.
- To avoid injury or damage to the fitting, ensure that power leads and screws are secure before connecting the power.
- Select a suitable location away from liquids and hazards.
- Ensure that the fitting does not come in contact with corrosive chemicals, etc.
- To clean, wipe with a damp clean cloth. Never soak the fitting with water.

Troubleshooting		
PROBLEM	POSSIBLE CAUSE	SUGGESTED SOLUTION
Does not work. (New installation)	Wiring loose or no power to the fitting.	Check your circuit breaker/safety switch box and turn on power to your circuit.
		Unplug the fitting and test in a functional socket outlet with power. If the fitting does not switch on then contact your nearest Beacon Lighting store. If the fitting is working, have your licensed electrician check the wiring or socket outlet to the fitting.
Does not work. (Existing installation)	No power to the fitting.	Check your circuit breaker/safety switch box and turn on power to your circuit.
		Contact your nearest Beacon Lighting store.
Flickers when dimming. (New installation)	Non-compatible dimmer used.	Check the dimmer used. Ensure the dimmer used is on the list of compatible dimmers in this manual.
	Some dimmers have a variable loading adjustment function. eg. Lucci LEDlux SKU# 290998 dimmer. This may not have been adjusted during the installation of the dimmer.	The variable resistor needs to be adjusted to suit the fitting load to reduce the flickering.
Flickers when dimming. (Existing installation)	Dimmer position on low.	Ensure the dimmer position is on the maximum setting before turning on the fitting and adjust the dimmer down to your desired light level.
Buzzing sound.	Non-compatible dimmer used.	Check the dimmer used. Ensure the dimmer used is on the list of compatible dimmers in this manual.
Uneven light start up.	Dimmer position on low when switched on.	Ensure the dimmer position is on the maximum setting before turning on the fitting and adjust the dimmer down to your desired light level.

Specifications

SKU #	177650	177651	177652	177653	177654	177655
Colour	White	Black	Brushed Chrome	White	Black	Brushed Chrome
Rated Voltage	INPUT: 220-240V~ 50Hz, OUPUT: 32.1-37VDC, 0.28A, constant current,					
Rated Wattage	12W					
LED Specs	LUMINUS LED, 3000K, 650 initial lumens			LUMINUS LED, 4000K, 650 initial lumens		
Dimmer Information	Highly Recommended Dimmers			Compatible Dimmers		
	Lucci LEDlux SKU# 290998			DIGINET LED Smart MEDM; Clipsal 31E2RUDM, 32E450TM, 32E450UDM, 31E2PUDM and 32ELEDM; HPM: Cat. 400T		
Weight	0.58kg					
Cut-out Size	Φ82mm					
IP Rating	IP20					
Dimensions	D:90mm x H: 110mm					
Serviceable Parts	LED module and LED driver are both serviceable.					
LED Driver Model #	TD011GIL-E028					